

UN56974/
UN56975

5-Shelf Bookcase

essentials

by UNION & SCALE™

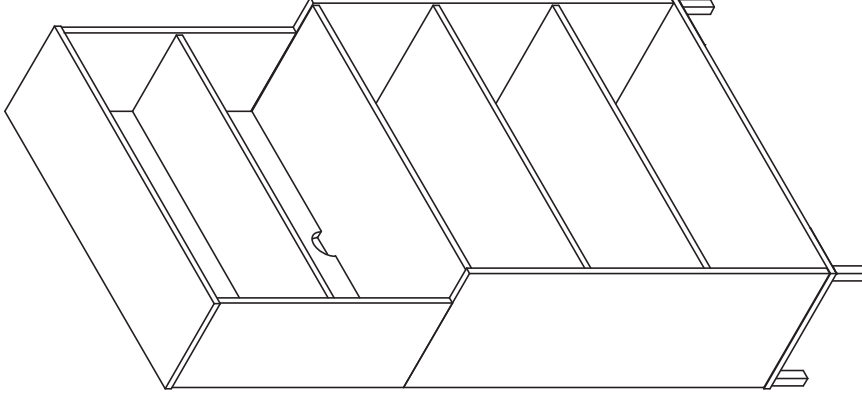

Instructions

Product Support 1-800-270-9557

Easy assembly.

Union & Scale is leading the way in taking some of the stress and frustration out of furniture assembly.

More logical instructions. No more “huh?” moments — we develop our instructions to have the right amount of detail you’ll need for easy assembly.

We’re here to help. If you’re confused during any step of the way, just call the number located at the bottom of the instructions pages.
You’ll get help from a friendly representative.

Need help with assembly?

Questions?

Call our Product Support experts
8:00 am-8:00 pm
Eastern Time: 1-800-270-9557

In-Office assembly (additional fees apply)

Call our In-Office Assembly Services
Monday-Friday 9:00 am-7:00 pm
Saturday 9:00 am-5:00 pm
Eastern Time: 1-866-826-6622

Furniture that works for you.

Your business has its own unique personality.

At Union & Scale, we’ll help bring it to life through furniture and décor that connect perfectly with each other and your team.

Union & Scale™ provides solutions that enable people and organizations to perform at their best.

We stand behind our products and materials. If for any reason a Union & Scale™ product does not meet the performance expectations, please contact us at 1-800-270-9557.

Included Parts

- ① Lower Backer (x1)
- ② Left Lower Side Panel (x1)
- ③ Lower Top (x1)
- ④ Bottom Panel (x1)
- ⑤ Shelf (x1)
- ⑥ Shelf (x1)
- ⑦ Upper Backer (x1)
- ⑧ Left Upper Side Panel (x1)
- ⑨ Top (x1)
- ⑩ Shelf (x1)
- ⑪ Right Upper Side Panel (x1)
- ⑫ Right Lower Side Panel (x1)

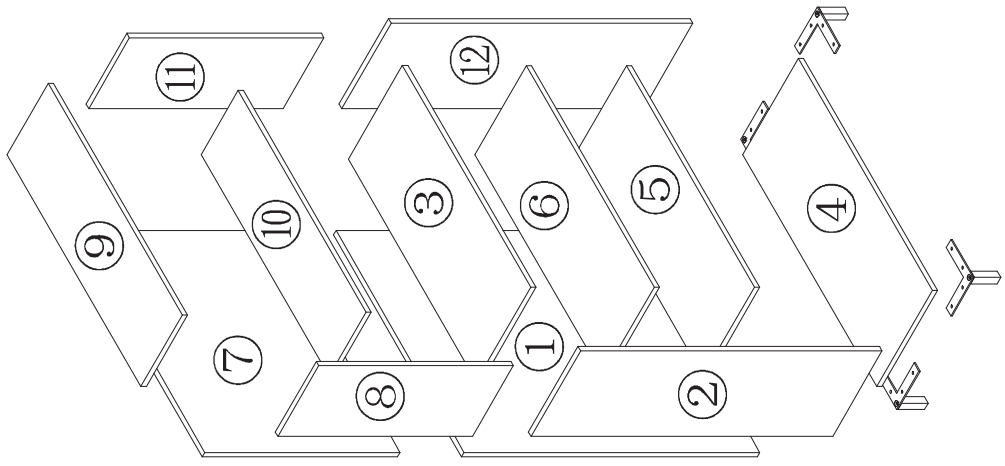

Included Parts

- Ⓐ Cam Lock & Klix Cam (x32)
- Ⓑ Screw (x4)
- Ⓒ Screw (x16)
- Ⓓ Hidden Cam (x32)



- Ⓔ Shelf Holder Screw (x12)
- Ⓕ Cover (x32)
- Ⓖ Dowel (x12)
- Ⓗ Allen Wrench (x1)

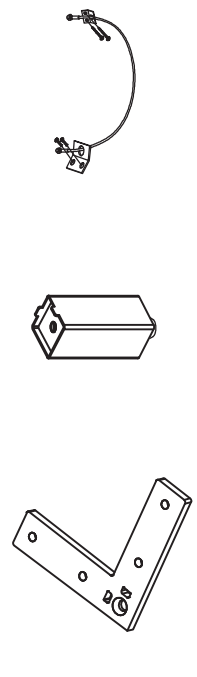

- Ⓛ Frame Leg L Connector (x4)
- Ⓜ Frame Tube Leg (x4)
- Ⓨ Wall Anchor (x1)

Required Tools



Assembly Tools Required
(Not included in package)

Each piece of hardware needed for each step is located in the corresponding segment in your Easy Parts Pack.

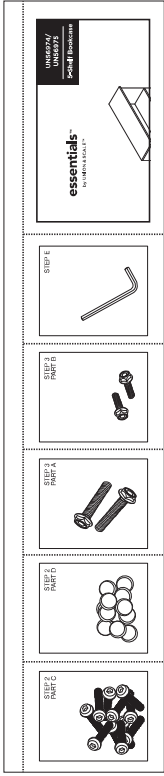

1

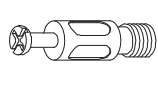

A (x2)



D (x2)

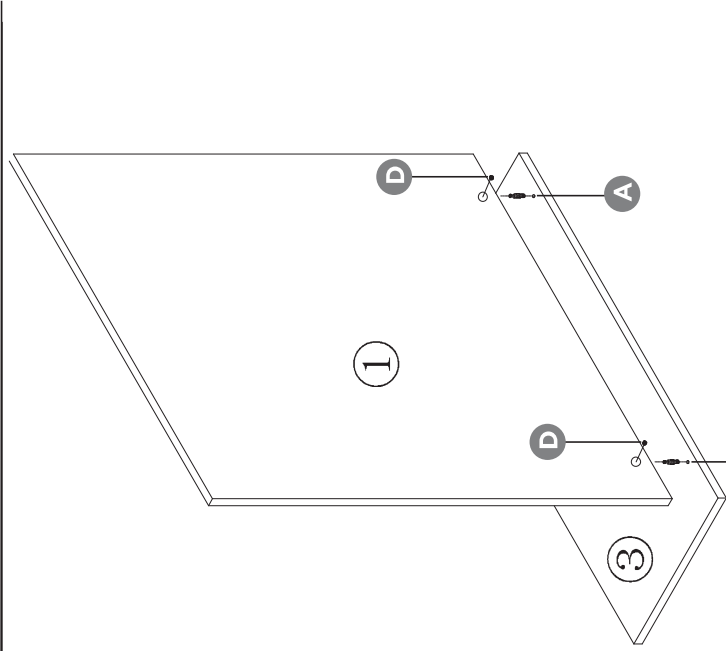

1

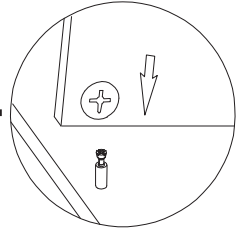

2

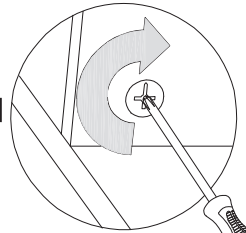

2

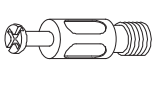

A (x4)



D (x4)

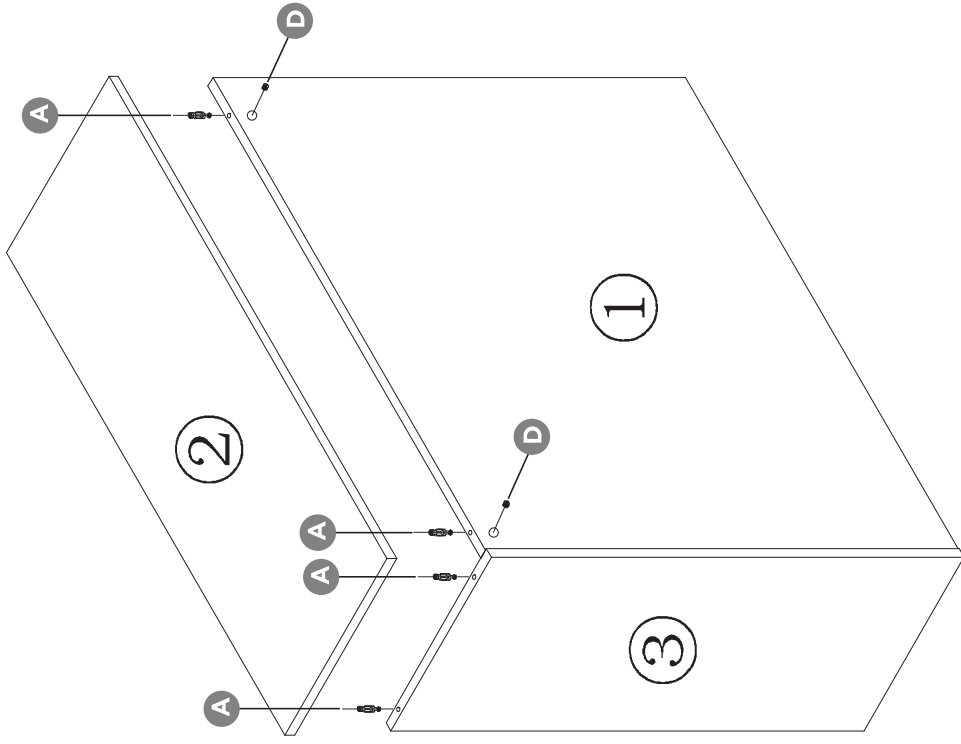

1

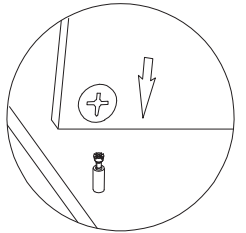

2

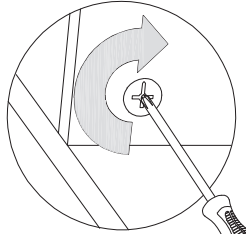

3



A (x4)



D (x4)

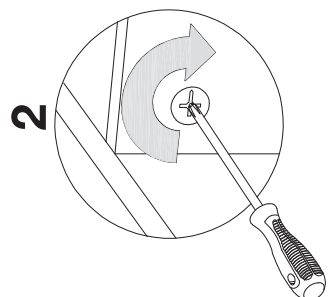
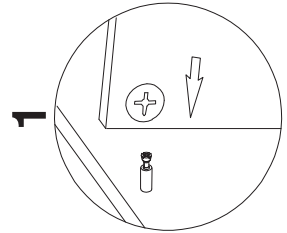
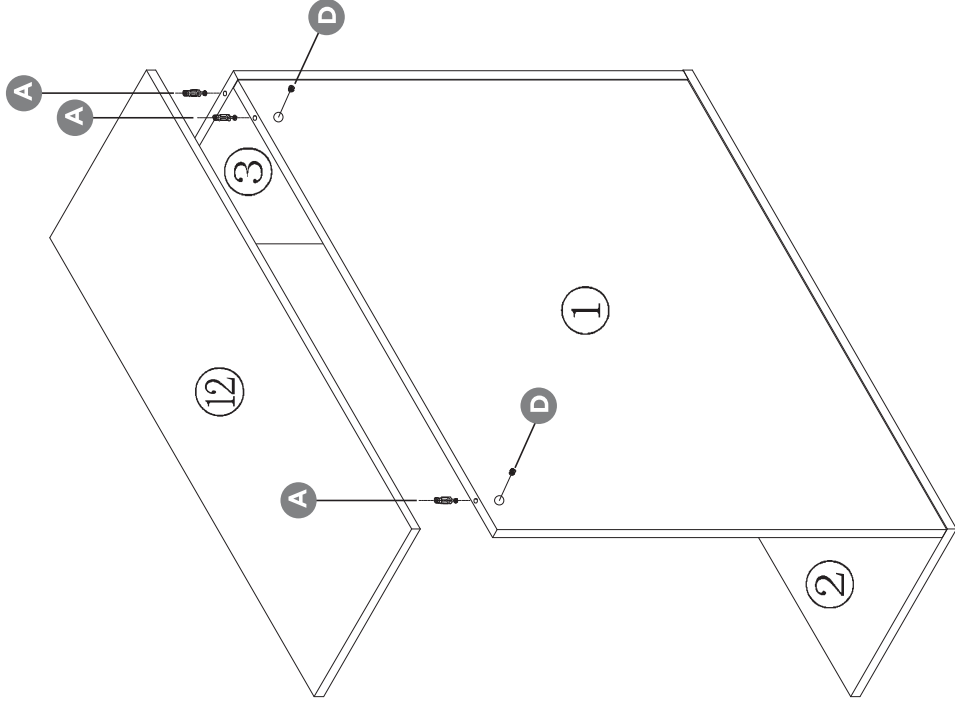

4



B (x4)



H (x1)

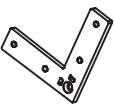

I (x4)

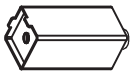

J (x4)

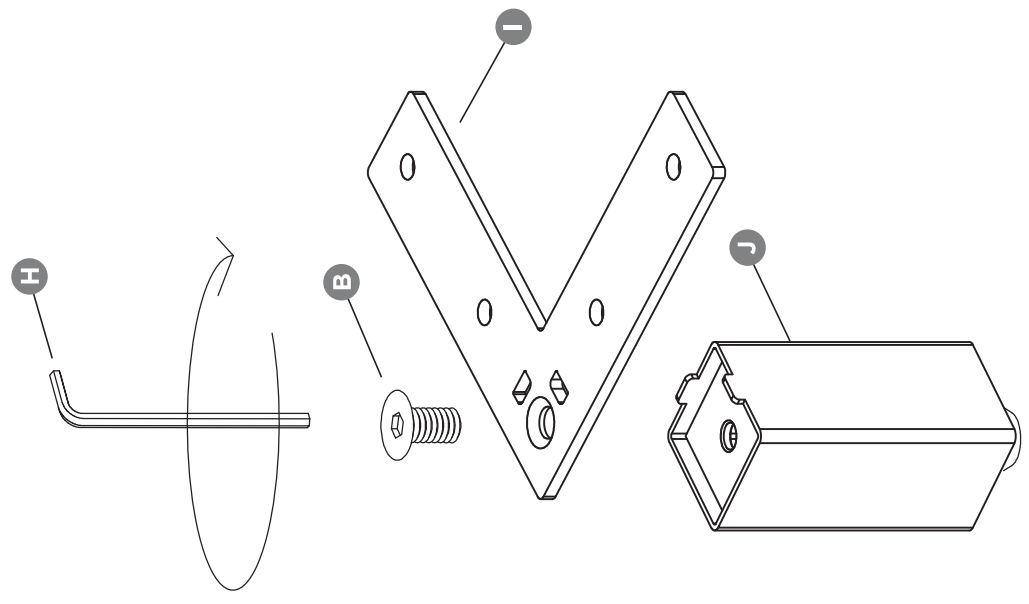

5



C (x16)

6



A (x6)



D (x6)

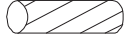

G (x4)

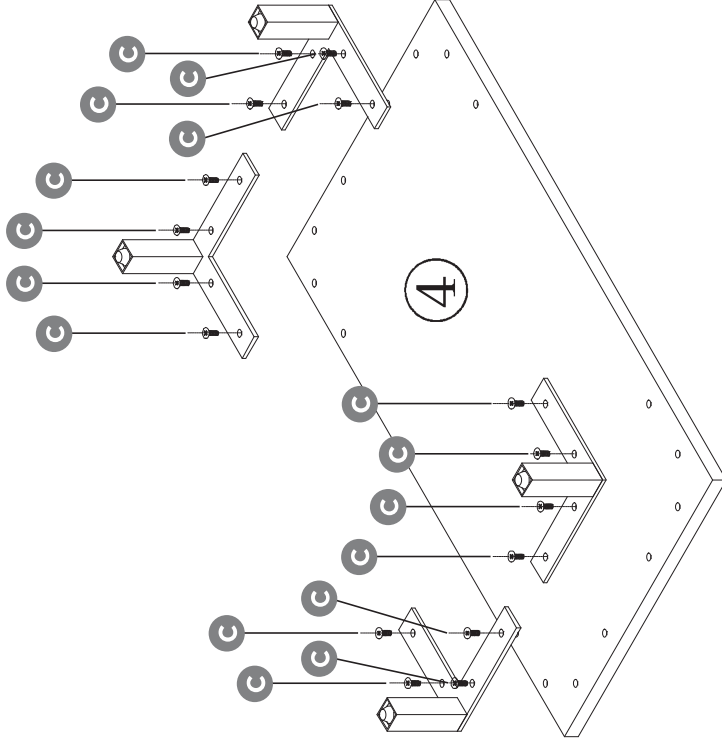
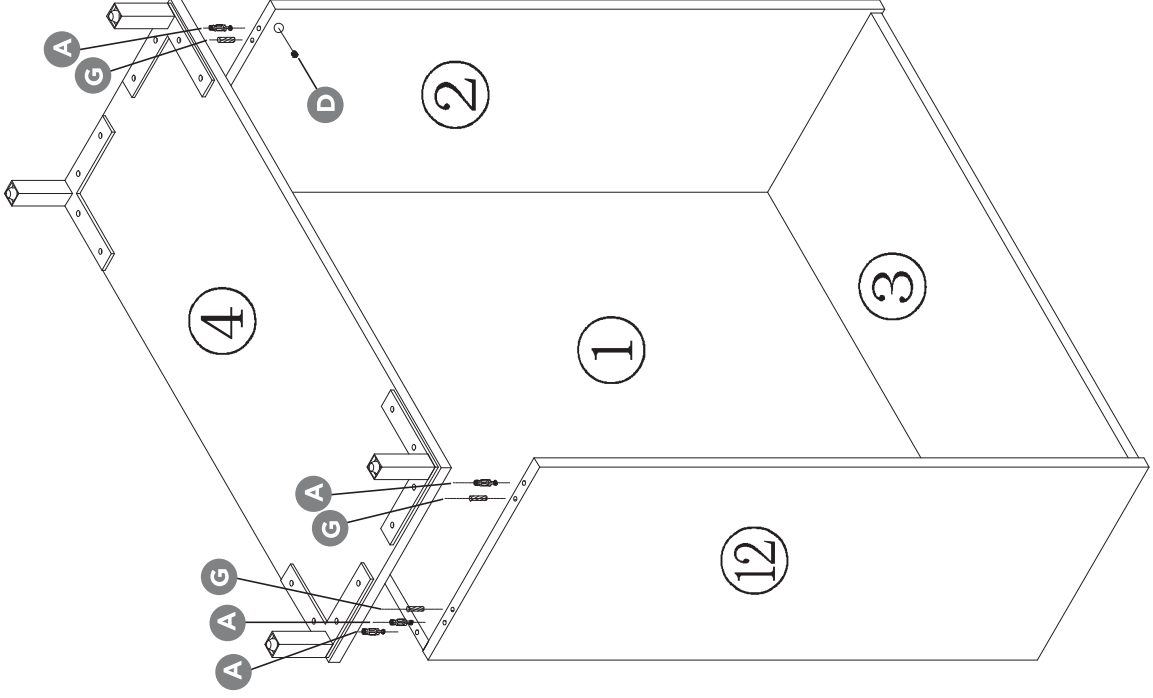

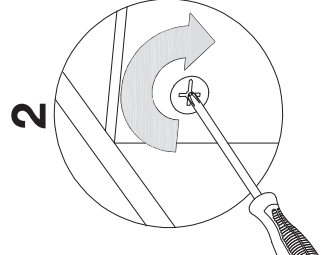
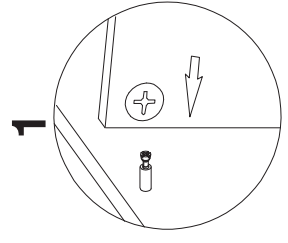
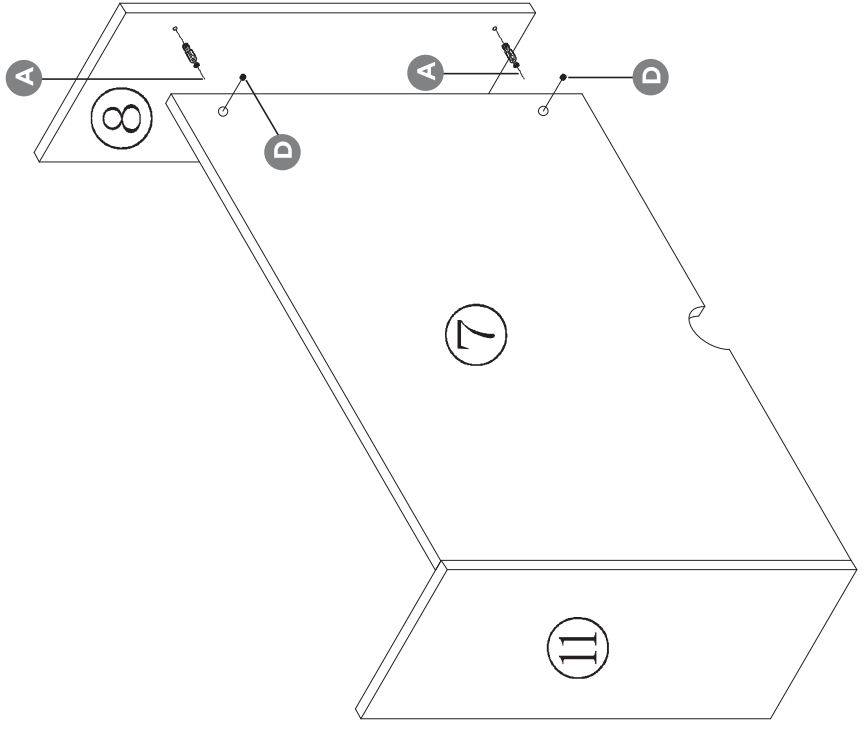
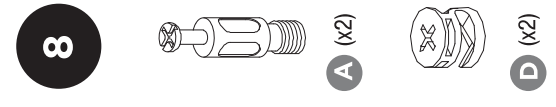
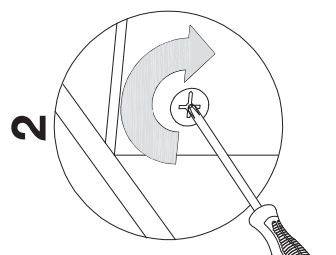
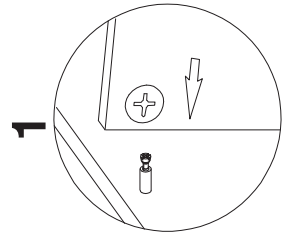
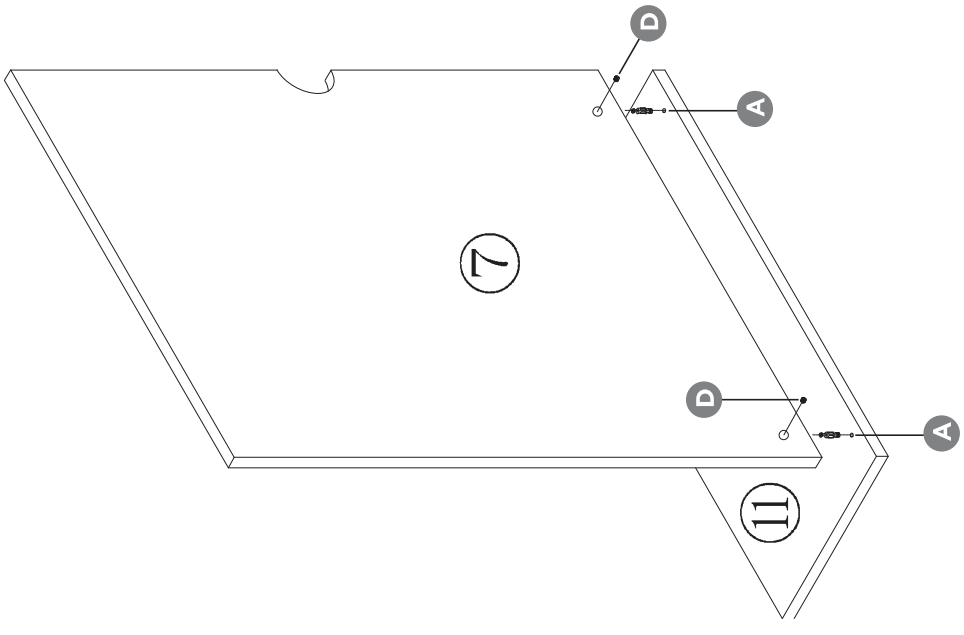

9



A (x6)



D (x6)

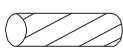

G (x4)

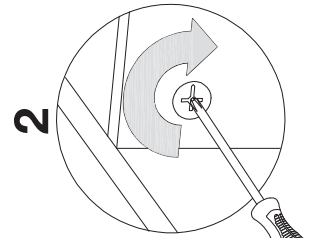
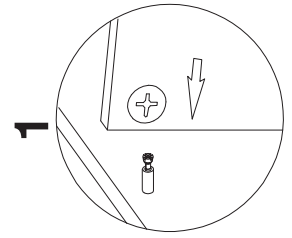
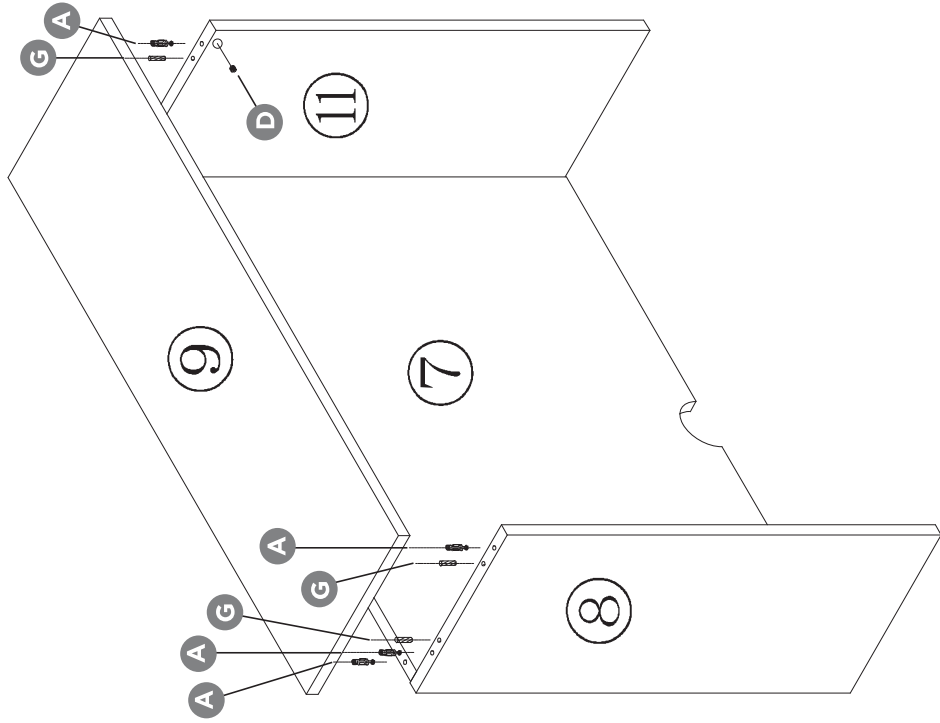

10



A (x6)



D (x6)



G (x4)

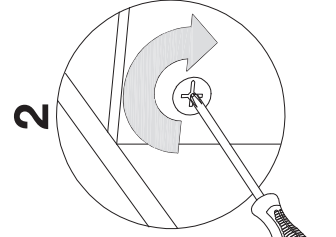
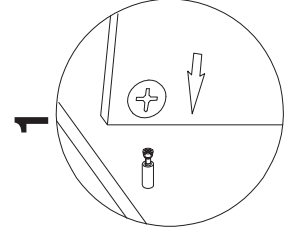
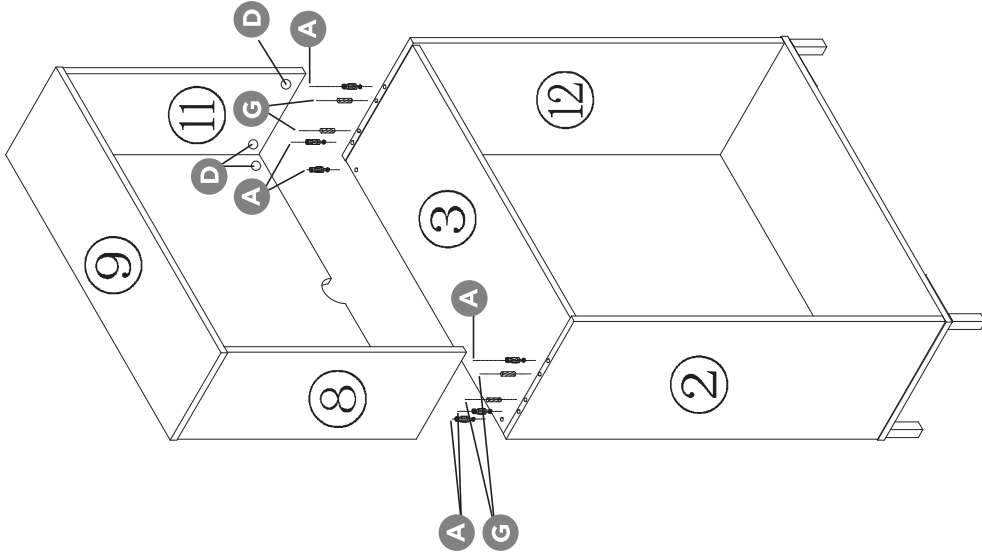

11



E (x12)

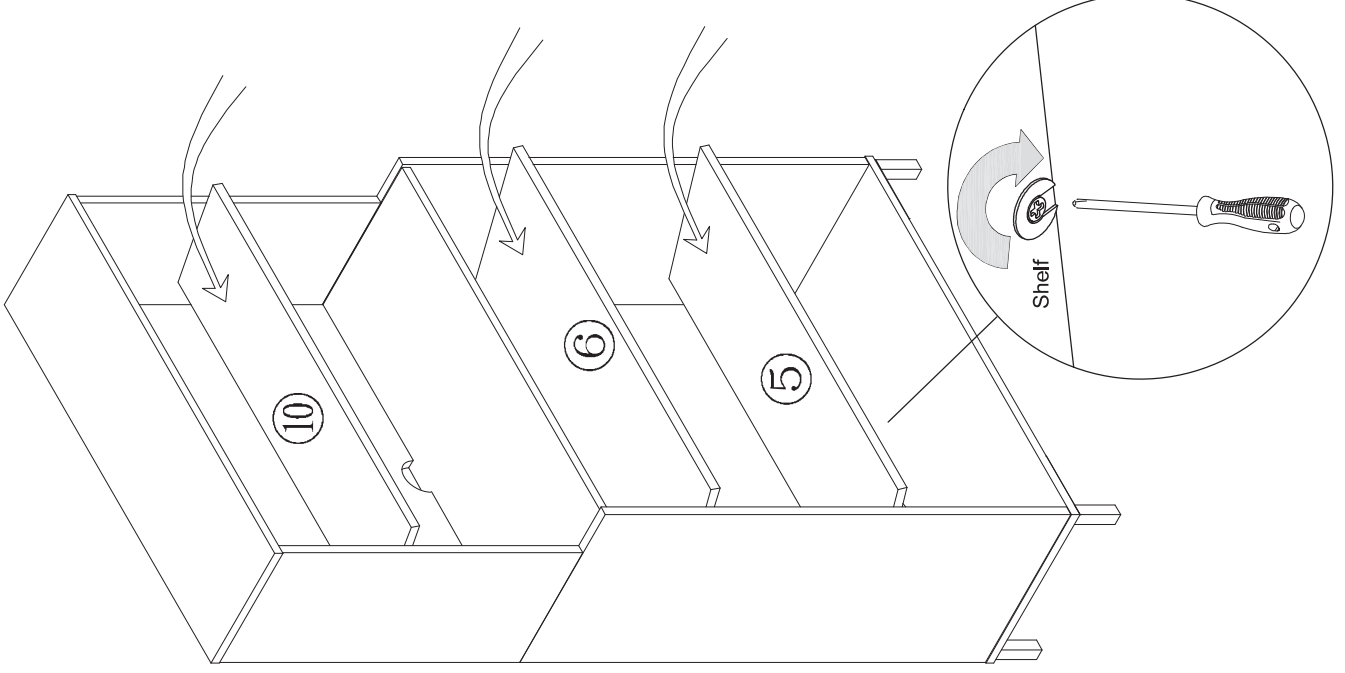
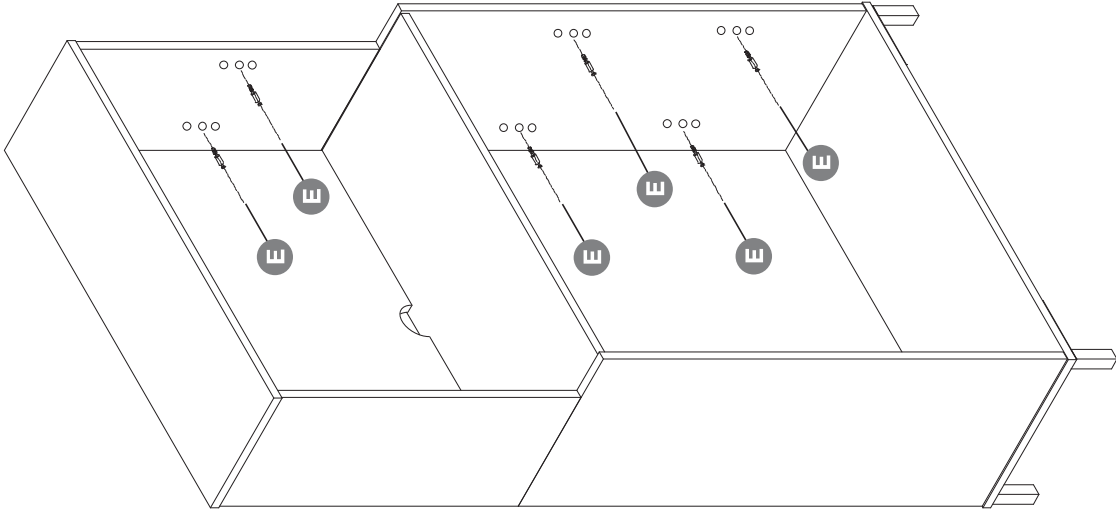

13



F (x32)

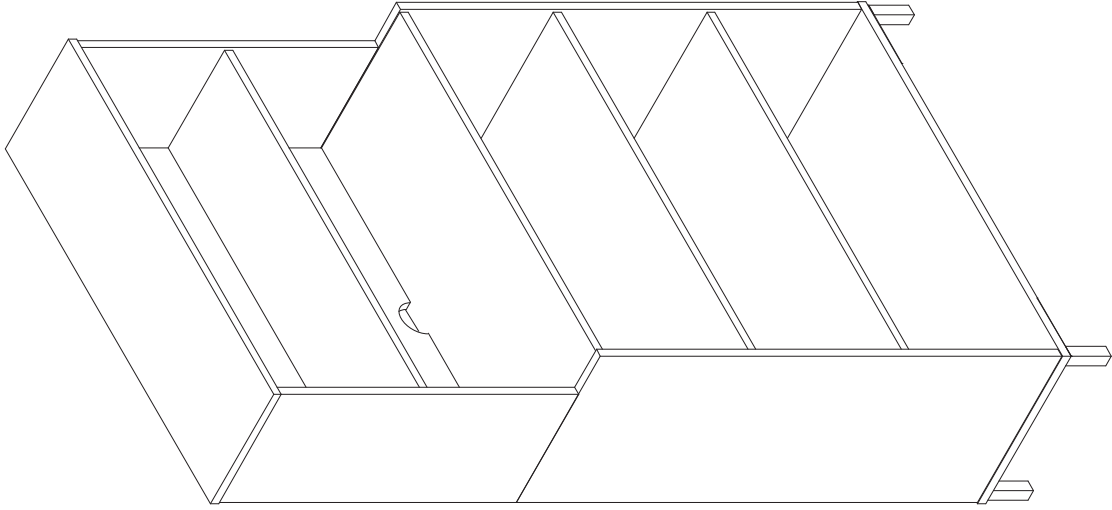

14



K (x1)

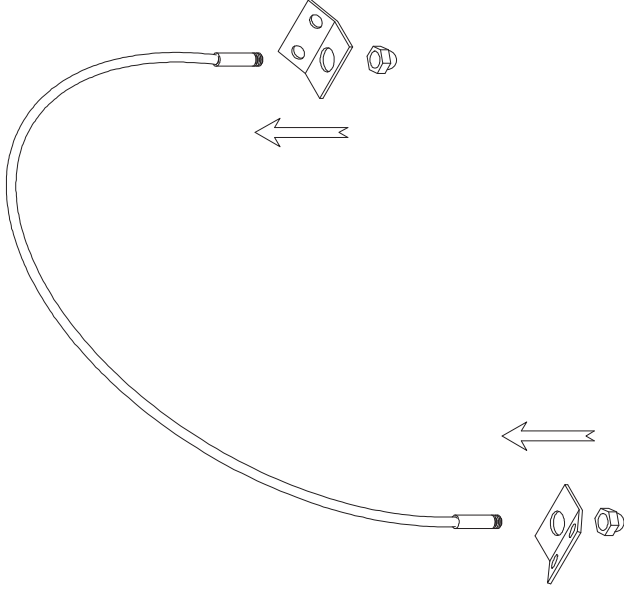

15



K (x1)

Behold, the finished product.

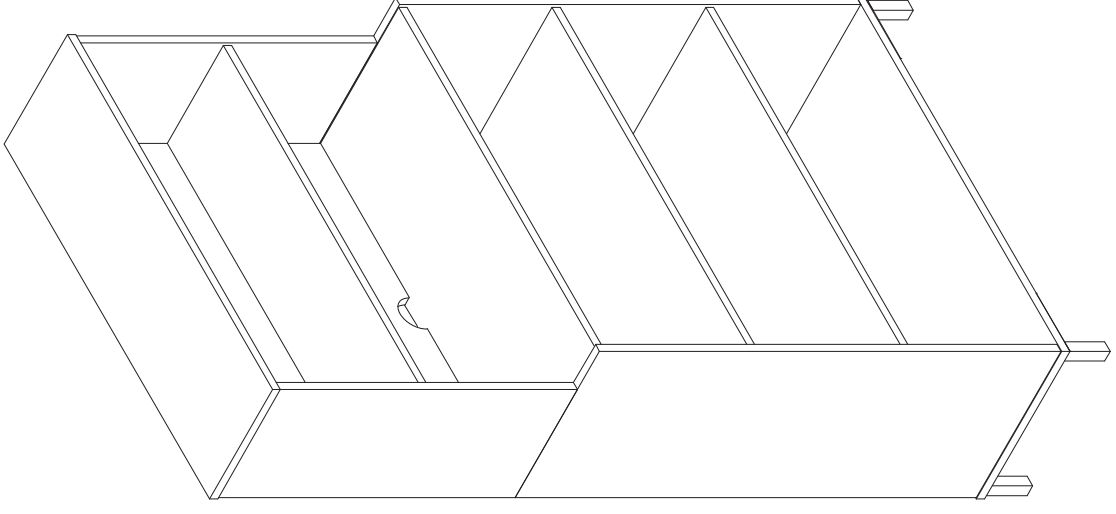
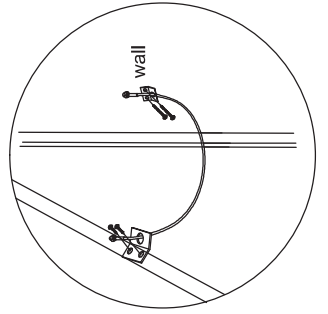
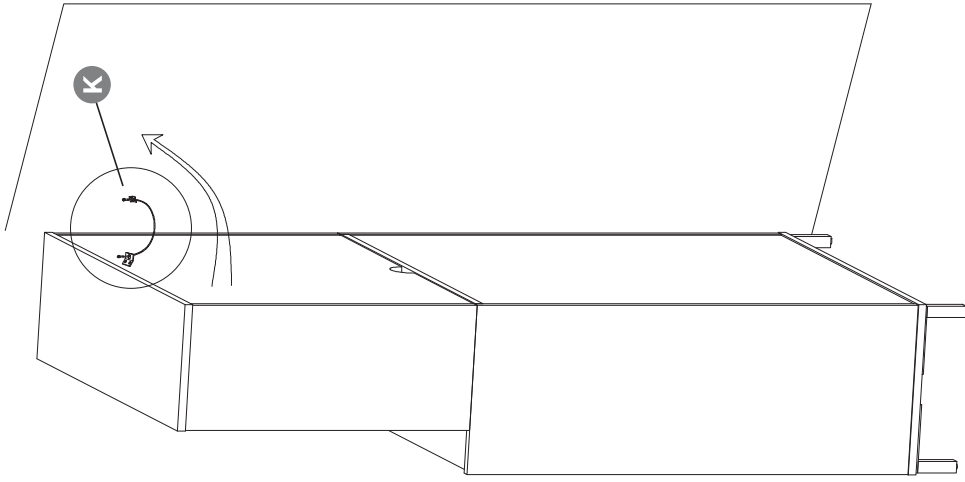

Warranty

Thank you for purchasing a Union & Scale™ Product. We promise to repair or replace any Union & Scale™ product or component that may have any defects in material or workmanship for as long as you, the original purchaser, own it. This warranty is subject to the provisions below. Staples' sole obligation and purchasers' exclusive remedy pursuant to these warranties are limited to replacement at Staples' sole discretion. There are no other warranties except as expressly set forth below, either expressed or implied, including any warranty of merchantability for any particular purpose.

The word defects in this warranty is defined as imperfections that impair the service, function or effectiveness of the product.

SEVEN YEAR:

Glides, casters and user-adjustable work surface mechanisms, laminates, veneer finishes and other materials which cover your Union & Scale™ product.

INFORMATION ON COLOR VARIATIONS & FINISHES:

Some natural variations occurring in wood, or other natural materials are inherent to their character, and thus can not be avoided. Therefore they are not considered to be defects. Staples does not warrant the color-fastness or matching of colors, grains, textures or other such materials. Customers' own materials selected by and used at the request of a user is therefore not warranted by Staples.

LIMITATIONS INVOLVING MATERIALS & COMPONENTS:

The materials and all components listed below are covered according to the following schedule from the date of sale to the original purchaser.

EXCLUSIONS:

This warranty does not apply to: damage caused by the carrier, modifications to the product, or attachments to the product not approved by Staples, nonstandard materials selected by and used at the request of a user, and products that were not installed, used or maintained in accordance with product instructions and warnings. Nor shall Staples have any responsibility for incidental or consequential damages resulting from the breach of this Warranty, including but not limited to inconvenience, rental or purchase of replacement products, loss of profits or commercial loss. Some states or provinces do not allow the exclusion or limitation

Warranty

of incidental or consequential damages so the above limitation or exclusion may not apply to you. This warranty gives you specific legal rights and you may also have other rights, which may vary from state to state or province to province. This warranty applies only to products sold within the United States of America and the Commonwealth of Canada.

TO OBTAIN SERVICE FROM THIS WARRANTY:

- A) Please contact us within 30 days (unless otherwise noted by the Dealer) of discovery of the defect. Prepare to confirm that you are the original purchaser of the product and provide necessary product information, such as serial number(s)/UPC number(s) from the product in question.
- B) Staples will gather all the pertinent information required regarding your claim(s), inspect the product and thus contact a Union & Scale™ Customer Service Representative.
- C) If Staples confirms that the product in review is eligible under the warranty conditions as stated above, the Customer Service Representative or another representative of the Company will determine whether to provide replacement parts, or authorize other arrangements at the sole discretion of the vendor Staples. No assembly/labor is included in this warranty.

TO CONTACT CUSTOMER SERVICE:

Our knowledgeable Service Representatives are ready to assist you in the case this warranty applies to you. Please be prepared to explain the defect in detail, model/style number, date and location of purchase, your name, address, phone number and have your original sales receipt.

Please contact us Monday–Friday (except all major holidays) at: 1-800-270-9557 from 8:00 am to 8:00 pm ET.